

Tiger
CB STOVE

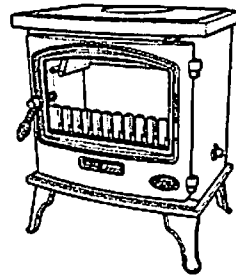



TIGER SUPERCLEAN CAST-IRON MULTI-FUEL STOVE



INSTALLATION AND OPERATING INSTRUCTIONS

document v. 150 of 03/08/10

LEAVE THIS DOCUMENT WITH THE HOUSEHOLDER !



THE INSTALLATION AND SERVICING OF THIS APPLIANCE MUST BE SUPERVISED BY A QUALIFIED SOLID FUEL ENGINEER. THE SUPPLIERS WILL ACCEPT NO RESPONSIBILITY WHATEVER FOR APPLIANCES NOT SO INSTALLED. A register of qualified engineers is available from:
UK: The Solid Fuel Association, 7 Swanwick Court Alfreton Derbyshire DE55 7AS Tel:0845-601-4406 www.solidfuel.co.uk
RoI: Irish Nationwide Fireplace Organisation, 162 Capel Street, Dublin 1 Tel:01-801-5959 www.fireplace.ie

THIS APPLIANCE BECOMES EXTREMELY HOT AND CAN PRODUCE POISONOUS GASES.

A fire-guard should be used if children or the infirm are present. The installer is required to EXACTLY follow these instructions and to completely comply with all local, national and international standards.

Building regulations for the UK, RoI and IoM can be found at
www.tiger-stoves.com

ASBESTOS: Tiger does not contain asbestos, but you should be careful to avoid disturbing any asbestos when removing an old installation.

FIRE CEMENT is caustic - wash your hands thoroughly after using it.

WEIGHT Protect your spine by moving the stove only with assistance.

FUME EMISSION: Properly installed and operated this appliance will not emit fumes into the dwelling. Occasional fumes from de-ashing and refuelling may occur. However, persistent fume emission is potentially dangerous and must not be tolerated. If fume emission persists, then the following immediate action should be taken:

(a) open doors and windows to ventilate the room. (b) let the fire go out or eject and safely dispose of fuel from the appliance. (c) check the flue or chimney for blockage and clean if required. (d) do not attempt to re-light the fire until the case of the fume emission has been identified and corrected. If necessary seek expert advice

Conforms to
EN 13240:2001+A2 2004
Independently tested in 2010 by SGS
Approved Laboratory No 0608



Intermittent burning solid fuel roomheater for
installation with a single dedicated chimney

Fuel	Wood (Beech)
Efficiency	74%
Rated Output	5 kW
CO (at 13% O ₂)	0.15 %
Mean Flue Temperature	320° C
Clearance to combustibles	40cm
Smoke Emission	78 mg/m ³
Gas flow	4.9 g/sec
Flue Draught	Minimum 12 Pa
Mass	96 kg

Other fuels: Anthracite, peat and smokeless fuels

BEFORE YOU BEGIN

YOUR CHIMNEY creates the draught which makes your Tiger work - it must:

- Generate a draught in use of at least 12Pa (0.05ins wg)
- Be capable of withstanding the temperatures generated.
- Be incapable of leaking fumes into the dwelling

This will commonly be achieved by it:

- Being at least 5m high.
- Terminating at least 1m above any roof ridge.
- Having an internal cross-section not less than 0.018m² (eg 150mm dia) and never more than 0.14m² (eg 375 x 375mm)
- Being free from even the slightest crack or source of leakage.
- Having no bends sharper than 45°.
- Being entirely free of obstructions and swept by a qualified chimney sweep.
- Being connected only to this one appliance.
- Being of thick (100mm+) masonry or otherwise adequately insulated.
- Conforming to local building regulations.

Special rules apply where the flue passes through timber, thatch or other vulnerable materials- take specialist advice.

INSTALLATION CLEARANCES The stove must be placed on a solid non-combustible hearth conforming to building regulations. There must be no combustible material, including fuel, within: Rear 40cm, sides 30cm. If the Europa Hi-Leg unit is fitted hearth temperature will not exceed 100°C, and light duty hearth material may be used. If the Europa Hi-Leg unit is used as a log store, logs must not be placed higher than the central 'bridging' member.

LOAD BEARING Tiger is heavy - take care to ensure that the floor has adequate load-bearing capacity and consider fitting a load distributing plate if necessary

Tiger SuperClean Stoves may be used in smoke control areas strictly in accordance with these instructions, when burning:

UK: Untreated wood logs or smokeless fuels (s21 of the Clean Air Act 1993)

RoI: Wood logs, smokeless fuels or peat briquettes, but *not* petroleum coke (Control of Atmospheric Pollution Regulations, 1970)

ASSEMBLY

STANDARD LEGS: Attach the legs if required. We suggest that the two legs with fixing holes be fitted to the back of the stove, for neater appearance. If the hearth is uneven, fit one or more washers between any leg and the stove body to lengthen it. Fix the stove down to the hearth, through the legs, using the screws and plugs provided.

'AMERICANA' COOKTOP KIT OPTION (supplied separately): Remove the two bolts located to the left and right inside the underneath of the standard top. Remove and discard the standard top, taking care not to damage the fibre seal. Fit the 'wings' to the cooktop and bolt the whole assembly back onto the stove body. Do not over tighten.

'EUROPA' HI-LEG KIT OPTION (supplied separately): Assemble the left, and right hi-legs *loosely* to the central bridging member. Attach to the underside of the stove using the bolts supplied before fully tightening. Note the 'Installation Clearances' on page 1. When used as a log store, logs must not be placed higher than the central 'bridging' member.

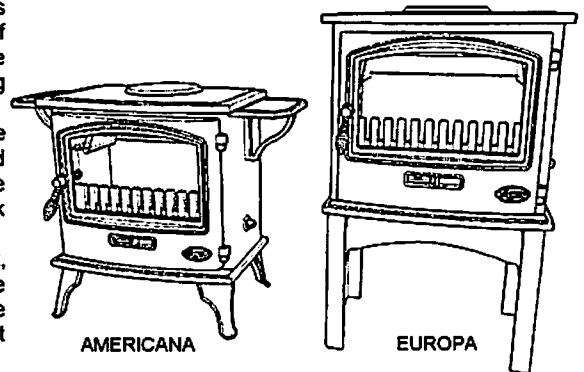

FITTING

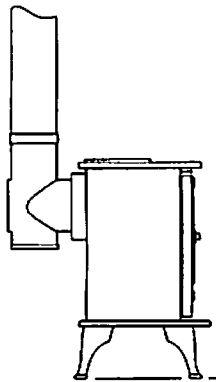

Rear outlet connected to top outlet by 'T' piece with cleaning door. This is the preferred method of installation.

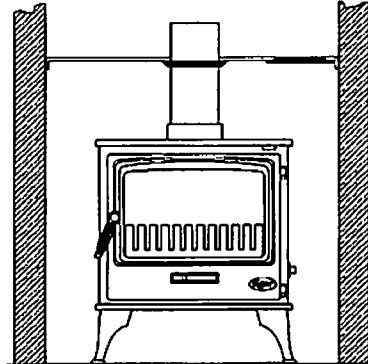

Top outlet through fully-sealed steel closure plate (fitted with cleaning door) into old, oversized, chimney with steel sealing collar.

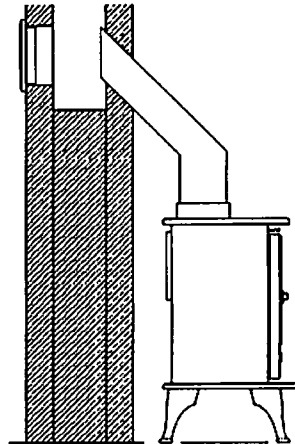

Top outlet with 45 degree bend sealed into masonry chimney with cleaning door on opposite side.

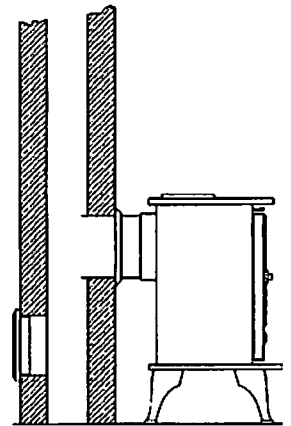

Rear flue connection into chimney with sealing collar. Cleaning door on opposite side.

FLUE CONNECTION: Fasten the flue outlet and blanking plate to the top or back flue outlet with screws and nuts provided. Tiger can be connected to the chimney (using approved flue pipe components) in several ways, four of which are shown above. Whichever method is used it is imperative that: (1) The route for gases from the stove to the chimney terminal is completely air-tight; seal all joints with fireproof cement and/or heatproof rope. (2) It is possible to sweep the entire length- access doors may be required. (3) The entire construction is of durable fireproof materials- composite board is not a suitable material for closure plates, which should be of steel or concrete. Tiger should be secured to the hearth by screwing through the fixing holes drilled in the legs.

AIR SUPPLY Tiger needs air to breathe - there must be a permanent air supply into the room in which the fire is installed equal to at least 5.5cm² per kW heat output. While it is commonly accepted that this air for an appliance below about 5kW in an older (before c1980) property can often be supplied by air naturally leaking around windows etc, in any case of doubt fit a fixed air vent. A extractor fan, or another fireplace or heater can remove this air, even if fitted in a different room.

CO DETECTOR Carbon Monoxide is a poisonous gas, produced by this stove. It is wise to fit a CO alarm near the stove.

LIVING WITH A TIGER

LIGHTING Empty the ashes. Place two or three firelighters close together, or screwed-up paper covered with dry sticks, at the back of the grate and light them. When they are burning well gently fill the fire *very full* with dry fuel, close the door and set the air control slide to the 'high' (right) position.

FILLING: When using mineral fuel, don't fill above the level of the lining bricks.

CONTROL How fast the fire burns depends on how much air reaches the fuel. The Tiger has two air controls, one below the window ('primary' ⊕) and one above ('airwash control' ⊙). Move the slides to the right for highest output, to the left for 'low'.

Our tests indicate highest efficiency on wood with the primary control all but closed and the airwash 2/3 open. Anthracite works

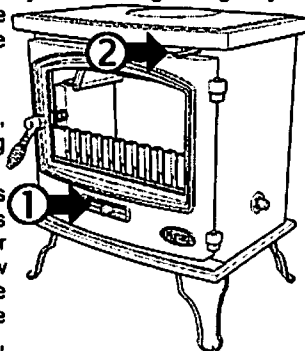

best with the airwash closed and the primary 1/3 open. But the best settings will depend on your fuel, air supply and flue draught and can only be found from experience. To prevent castings from cracking, the first fire lit in your Tiger should be small- made with little fuel and the air slide set to 'low'.

EMPTYING ASHES Operate the de-ashing mechanism by locating the operating tool onto the boss on the right-hand side of the stove and moving it backwards and forwards a few times. Use the tool to open the door and lift out the ashpan. Remember to let ash cool before disposing in plastic sacks or dustbins. There is no need to empty every last speck, but ash should never be allowed to build up so that it comes into contact with the underside of the grate.

EXTENDED BURNING Allow the fire to burn down to a low, hot firebed. Set the air control to 'low', empty the ash and fully fill with hard fuel such as anthracite (smaller sizes are best).

CLEANING Wipe the stove body with a slightly damp cloth when it is cool, don't use abrasives, metal polish or 'cream' cleansers as they can scratch the surface. Polished parts can be brightened

using wire wool. Operating the stove for a few minutes at high output will usually burn-off any window deposits left by tarry or wet fuels. After a period of use tiny hairline cracks may appear on the window, this is not a fault and will not increase the risk of breakage but is a characteristic of the toughest and most heat-resistant material currently available.

OPENING THE DOOR Tiger is designed to be operated only with the door closed. Open the door slowly when refuelling or de-ashing to minimise fume emission.

FUELS

There is no 'perfect' fuel, so we strongly recommend that you try a selection of fuels (or mixtures) to find which suits you best. Do avoid dusty materials like sawdust, they can burn far too violently.

SMOKE CONTROL: In certain areas special rules apply to reduce smoke nuisance. Check with your local authority.

WOOD only emits as much carbon to the atmosphere as the tree took in when growing, so wood is considered the 'carbon neutral' fuel. When wood is cut down its cells are full of water. Burning such wet or 'green' wood wastes heat in making steam and produces flammable, acidic tars which will cling to, and rapidly damage, your stove and chimney. Split logs will typically take two years to become reasonably dry, round logs much longer. Cracks in the ends, a hollow sound when tapped and bark falling away are all signs that a log may be ready for use. The fine, white residue produced when wood burns is not ash, but the remains of cell walls which can burn if kept hot enough, so don't de-ash a fire until absolutely necessary when using wood.

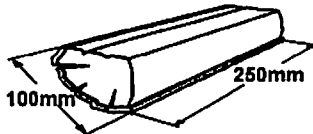

For best performance, and always for low smoke emission:

- Split logs lengthways for drying
- Use logs no bigger than about 100mm x 250mm
- Ensure logs are *absolutely dry* (less than 15% moisture)
- Fill the stove criss-cross, so air can circulate between logs.
- Fill 'little and often'
- Always have the airwash control (2) at least a little open.
- When first lighting, or reviving a fire from embers, use only very small, thin, dry, sticks.

JOINERY WASTE Dry wood offcuts will burn well, but don't expect softwood waste to burn as cleanly or for as long as hardwood logs.

PEAT: Sod turf must be thoroughly dry. BNM peat briquettes are approved for use in Smokeless Zones in the Rol.

LIGNITE (not smokeless) is a natural mineral, between peat and coal. It lights easily and burns well, but produces much ash

HOUSECOAL or **BITUMINOUS COAL** (not smokeless) makes lots of tarry smoke and large volumes of flammable gas which make it difficult to control and risk explosions. Despite its low cost, it rarely represents value for money. Don't use housecoal.

ANTHRACITE (Smokeless) is a natural hard, shiny form of coal. Slow to light, it can burn for very long periods with great heat. Despite its high price-per-bag it generally works out to be one of the cheapest of all fuels. Use the 'small nuts' size.

COKE (Smokeless) is coal from which the smoke has been removed. Sometimes difficult to light, it burns very cleanly.

BRIQUETTES Are compressed blocks of fuel, generally able to burn for long periods and remarkable for their consistency. 'Homefire' and 'Phumacite' are smokeless types while other brands are made from lignite, peat or housecoal.

PETROLEUM COKE sold as 'Petcoke', 'Longbeach' and under various proprietary names, is made from oil. Easy to light and to control, its exceptional heat and lack of protective ash mean that it

MUST NOT be used unless mixed with another fuel. Grate and liner life will be drastically reduced when using petroleum coke

HOUSEHOLD WASTES Some plastics give off toxic fumes when burned and remember that batteries and aerosols explode! The stove is not an incinerator, so only ever use the recommended fuels and **NEVER** use liquid fuels in any form.

PROBLEMS

Problems like those listed here are usually due to some difficulty with the installation, chimney or fuels, so please check back through this leaflet carefully. If necessary seek specialist advice.

SMOKE FROM THE CHIMNEY It is quite normal for a little smoke to be emitted from the chimney when the fire is cold, so, start the fire using only a very little fuel. Make sure that the airwash ② control is open and use only **VERY** dry wood or smokeless fuels.

DAMAGED LINERS Your stove gets very, very hot inside, it is quite usual for the replaceable liners to crack or craze. They need only be replaced when they have almost completely disintegrated. Help them last longer by using only *very dry* fuel.

POOR HEAT OUTPUT: A stove can heat a typical room of *about* 12m³ volume for each kW of output, so a 5kW model can heat up to (12 x 5) 63m³, a room of about 5m square. The actual size depends on the insulation and air-change ratio of the room. To attempt to heat a larger room will result in excessive fuel consumption and damaging overheating.

LACK OF CONTROLLABILITY This appliance is designed to always burn vigorously enough to eliminate smoke - adjust the heat output by how much fuel you put on, as well as by using the controls.

DIFFICULTY BURNING FOR EXTENDED PERIODS This stove is not designed for extended burning but for quick heat-up and occasional use. Longer burning can be achieved only using very hard fuels such as anthracite.

CONDENSATION onto cool surfaces inside the stove can be severe if fuel is in any way damp. *Use only very dry fuel.*

OVER-FIRING: It is possible to leave the fire too long with the controls set too high leading to 'over firing', seen as glowing metal parts, excessive chimney temperature and risk of parts falling or chimney fires. Always set controls to the lowest practical setting.

SMOKE COMING INTO ROOM Fumes are poisonous- smoke emission must **NEVER** be tolerated, causes might be:

NEW STOVE: There is often a smell and sometimes visible fumes as the paint cures. This normally stops after an hour or so.

INADEQUATE SEALS: Are all flue pipes and connectors *absolutely* gas-tight? Even the tiniest crack or gap can spoil the draught.

BLOCKED THROAT PLATE: Has soot and ash collected on the 'throat plate' above the inner back part of the firebox?

UNSUITABLE, BLOCKED OR UN-SWEPT CHIMNEY: The first requirement for correct operation is a sound chimney. Check the requirements earlier in this document and in any case of doubt engage a professional sweep or chimney engineer.

POOR AIR SUPPLY: Lack of air to the fire is a common cause of smoking and poor performance. Air supply problems may be worse in certain wind conditions (often incorrectly ascribed to 'downdraught', which is in fact very rare), where air can be sucked out of the room. The answer is to fit an air vent, as near to the fire as possible, facing into the usual wind direction.

DOWNDRAUGHT: Wind can blow *down* a chimney if there is something higher nearby such as a tree, hill or high building. Fitting an anti-downdraught cowl to the chimney top can cure this. Types which cannot be swept through are not recommended.

POOR CHIMNEY DRAUGHT- Chimney draught in use **MUST** be at least 12Pa.

CHIMNEY FIRE: In the rare event of deposits inside the chimney igniting (roaring sound + dense smoke and sparks from the chimney) immediately close the door, shut all air controls and call the fire brigade. Prevent fires by using *very dry fuel* and having your chimney swept regularly.

MAINTENANCE

MONTHLY- CLEAN THE THROAT PLATE and **CHECK THE DOOR SEALS** The throat plate (sometimes called a baffle plate) is the cast-iron plate inside the roof of the stove, item (9) in the diagram below. It serves to distribute flames towards the sides and top of the fire and so increase heat output. Remove the plate when the stove is cool to brush off any deposits of soot or ash which might cause a blocked chimney. Check that the door seals are undamaged, (replacing them if necessary) and that they fully seal against the stove

body. After a period of use the seals can become compressed - if this happens, open the door and lift it upwards to remove, screw in the hinge supports on the stove body and re-fit the door, repeating this until a tight seal is achieved. The door catch can be adjusted by unfastening the nut on the back of it and placing washers either in front of or behind the catch itself to move it in or out.

ANNUALLY- SWEEP THE CHIMNEY The entire length of the chimney from stove to outlet should be swept annually, or more often if smoky fuels are used.

REFURBISHMENT Should the stove body become scratched or dull, repaint it only with heat resistant paint supplied for the purpose and only when the fire is completely cold. A small jar of paint is supplied with the stove.

NEW PARTS Tiger has been extensively tested for safety - please don't try to modify it and always obtain *genuine* spare parts.

SPARE PARTS

- TIG5-1 SUPER Main casing
- TIG5-4 Main casing Base
- TIG5-6 Main casing Top
- TIG5-7 Flue outlet collar
- TIG5-8 Flue outlet blank
- TIG5-9 Throat plate
- TIG5-10 Grate frame
- TIG5-11 Front firebar
- TIG5-12 Grate
- TIG5-14 Door
- TIG5-15 Primary air slide
- TIG5-18 Hinge and pin
- TIG5-19 Ashpan
- TIG5-20 Window
- TIG5-21 Glass rope - large
- TIG5-22 Glass rope - small
- TIG5-23 Door catch assembly
- TIG5-24 Operating tool
- TIG5-25 Leg
- TIG5-26 Brick - rear
- TIG5-27 Brick - side left or right
- TIG5-28 Fire cement
- TIG5-29 Stove black paint
- TIG5-30 Screws and fixings pack
- TIG5-31 Spiral wire handle- black or silver

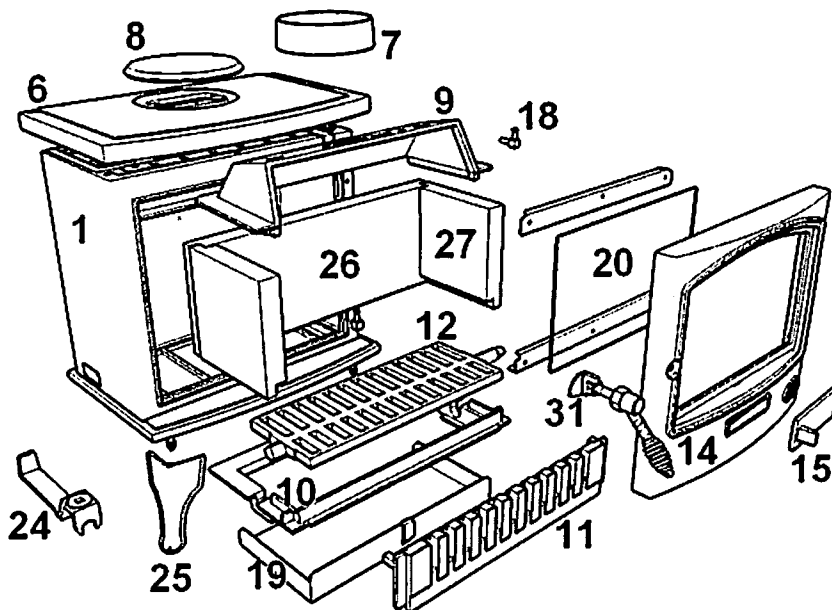

The Tiger stove is fully guaranteed for one year from the date of purchase, in addition to your statutory rights.



www.tiger-stoves.com
 Distributed in Europe by:

**Capital Fireplaces, Unit 12, Henlow Ind Est, Henlow
 Camp, Beds SG16 6DS UK
 Tel: 01462-813138**

**Percy Doughty & Co, Imperial Point, Stone Hill Rd,
 Farnworth Bolton BL4 9TN UK
 Tel: 01204-868-550**